

SLIM DOOR CATALOGUE

 **Alu.good**
Profile for windows and doors



ĐỘT PHÁ TRONG CÔNG NGHỆ CỬA NHÔM

Ưu điểm:

- Nhỏ, gọn, tầm nhìn rộng
- Không có ray dưới tránh vấp khi di chuyển
- Trượt ra vào nhẹ nhàng
- Phụ kiện đồng bộ
- Hình thức hiện đại, độ bền cao....

Ứng dụng:

Ngăn phòng, văn phòng, tiết kiệm không gian mở...



DẪN ĐẦU XU THẾ

Aluminum là vật liệu nhẹ, chịu lực tốt, công nghệ tiên tiến hiện nay cho ra đời những thanh profile hợp kim nhôm định hình kết hợp với công nghệ sơn hiện đại tạo ra sản phẩm cửa kết cấu tối ưu, màu sắc đa dạng với độ bền cao.

Với những ưu điểm đó Alugood cho ra đời sản phẩm cửa trượt slim mang công nghệ Châu Âu kết hợp với phụ kiện nhập khẩu hiện đại.



SẢN PHẨM CỬA SLIM ALU.GOOD

Nhôm: Nhôm độ quyền Alu.good được sản xuất riêng cho cửa trượt SLIM, độ dày 2mm

Màu nhôm: Màu đen bóng

Kính: Kính dán an toàn (6.38,8.38) Kính cường lực (6mm,8mm)

Bộ Phụ kiện: Bộ phụ kiện cửa nhôm chính hãng Alu.good

Quy cách: Cửa trượt treo, mở quay bằng hệ thống phụ kiện thông minh 1 cánh, 2 cánh, 3 cánh, 4 cánh, 5 cánh, 6 cánh...

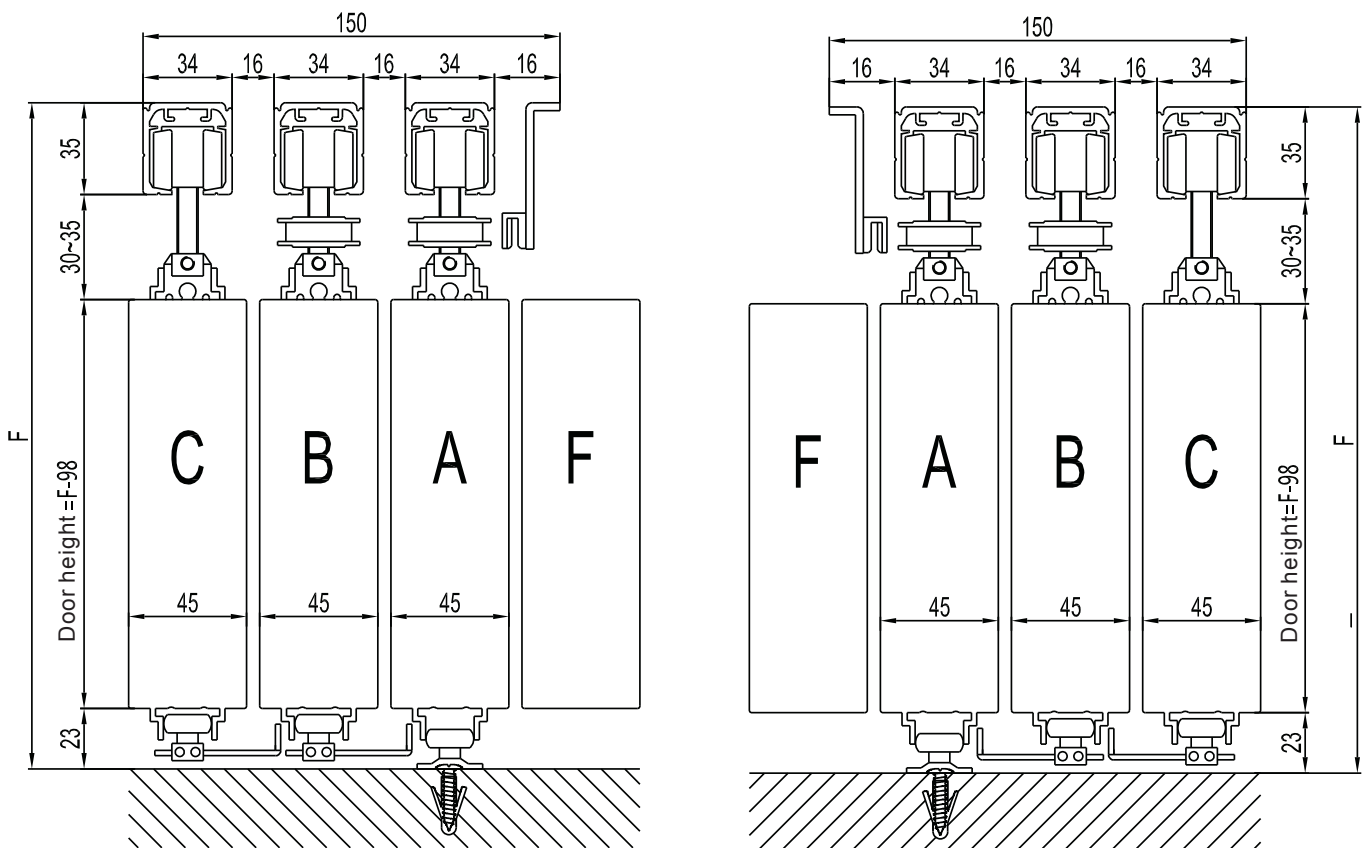



Mã sản phẩm

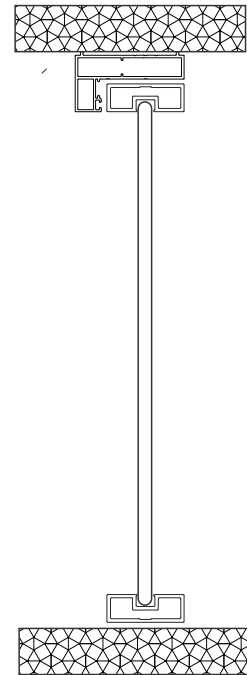
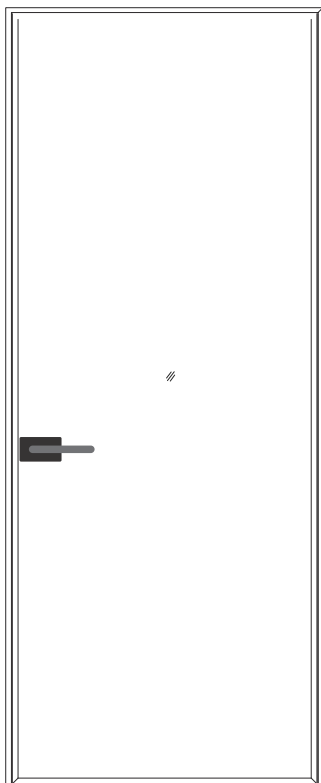

CỬA MỞ QUAY SLIM 2 CÁNH



Mã sản phẩm:

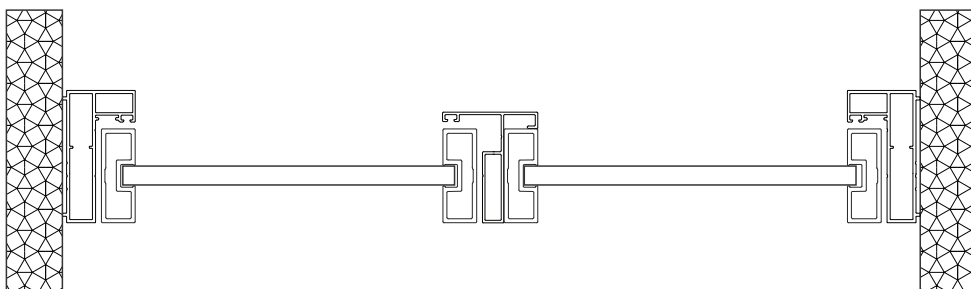
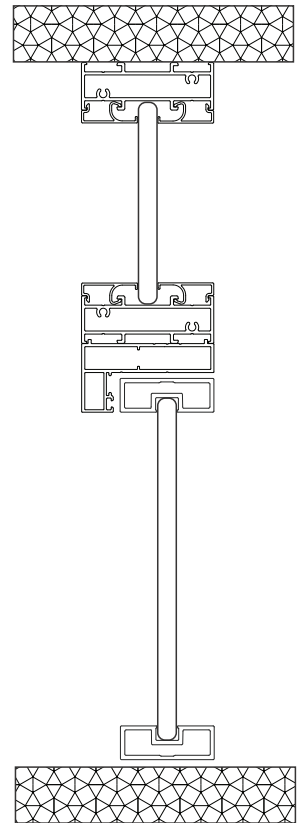
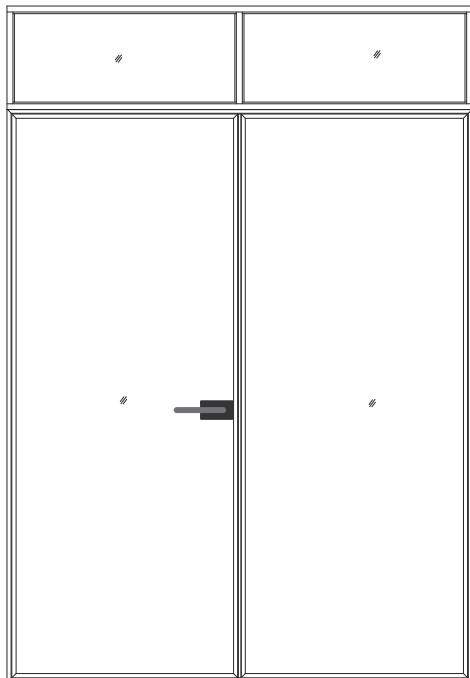



Mã sản phẩm:

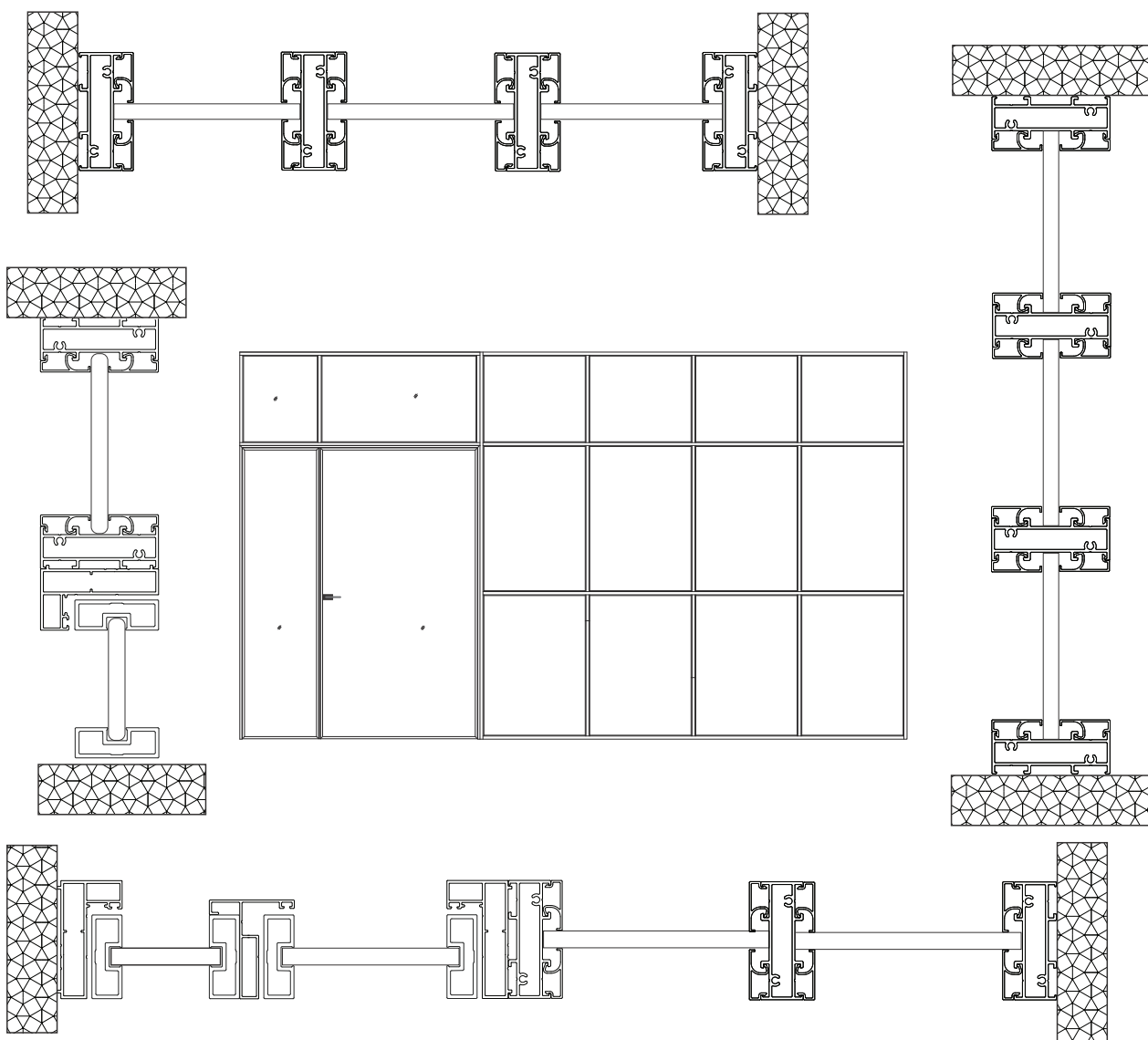



Mã sản phẩm: SL 01

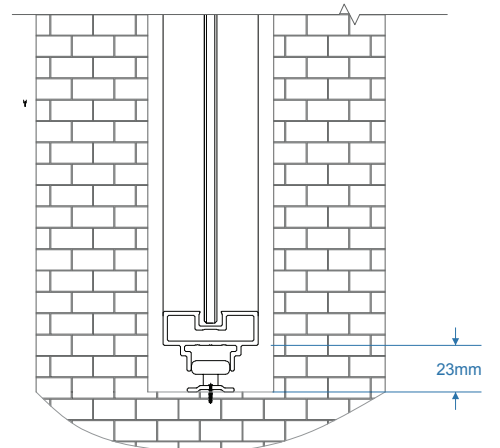
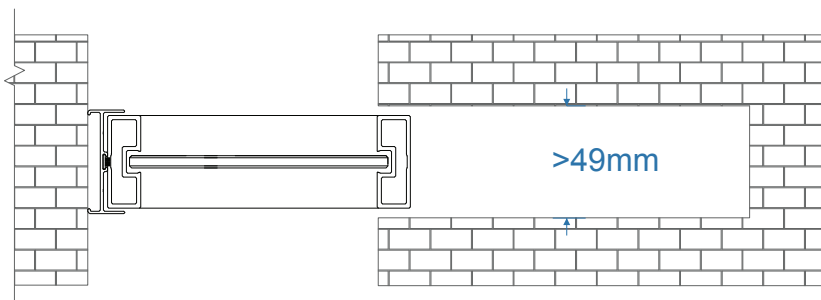
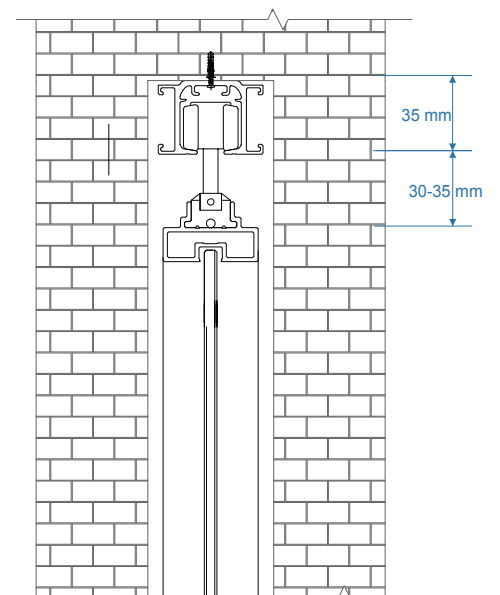
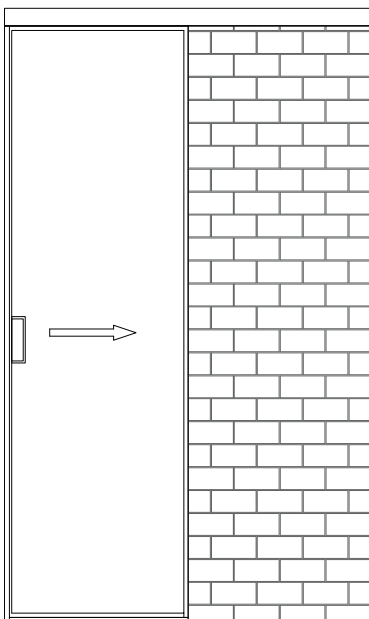

CỬA TRƯỢT SLIM 2 CÁNH

1 cánh lùa 1 cánh cố định



Mã sản phẩm: SL 02

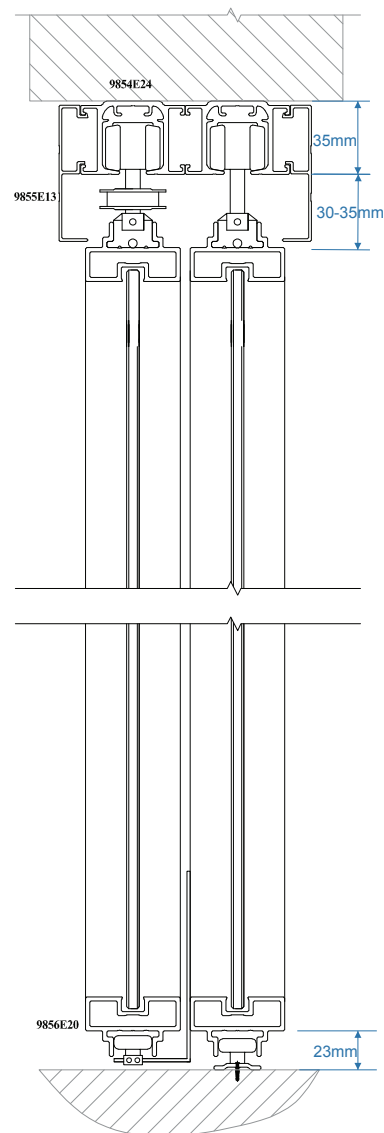
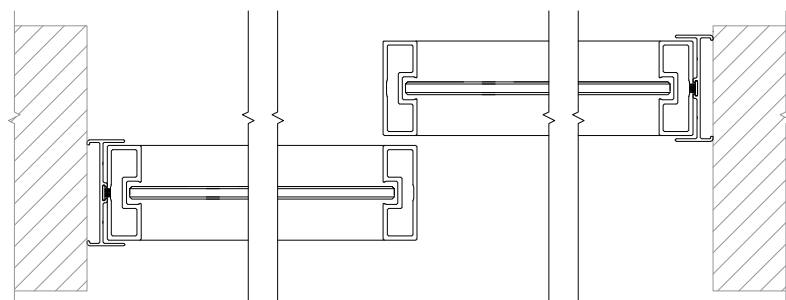
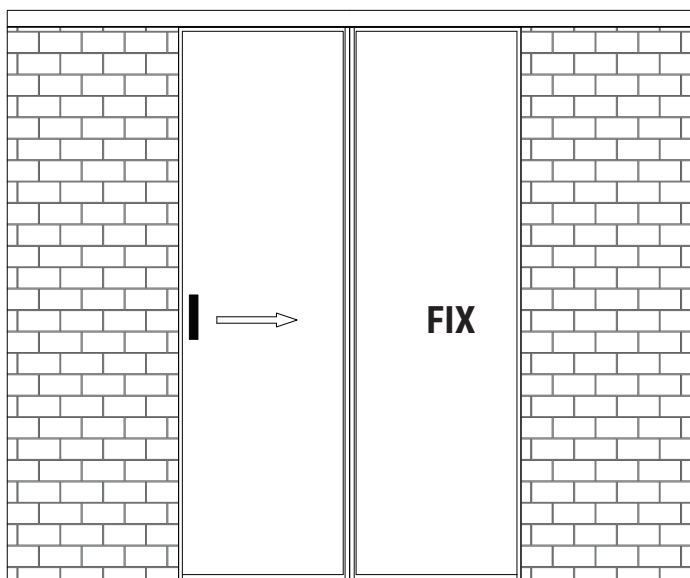

2 cánh lùa 2 bên (trên 1 Ray)



Mã sản phẩm: SL 02

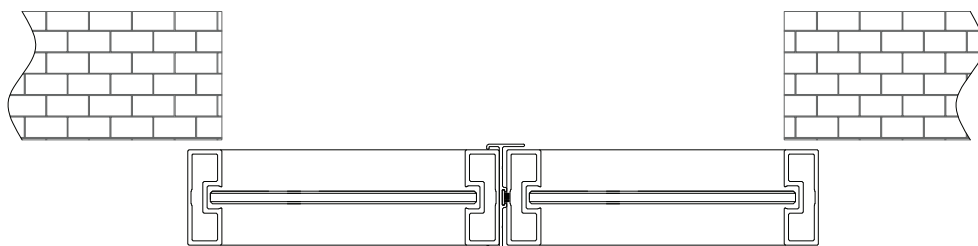
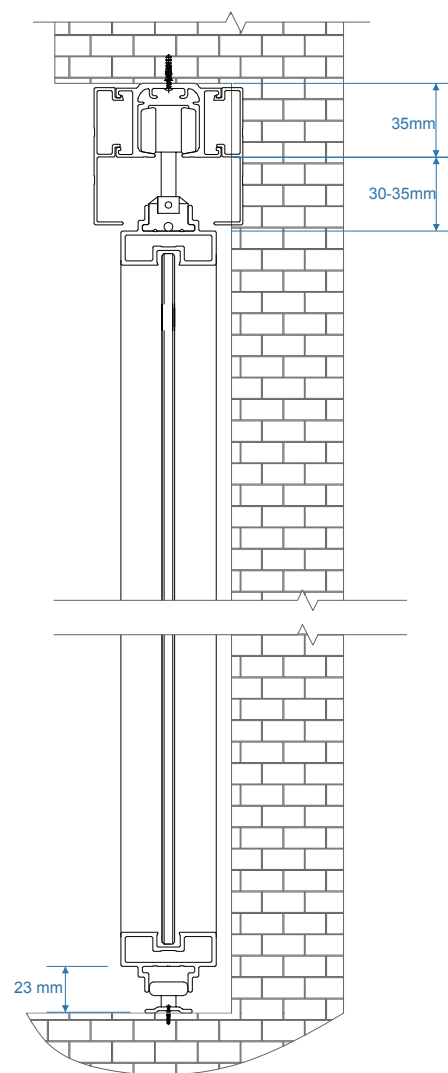
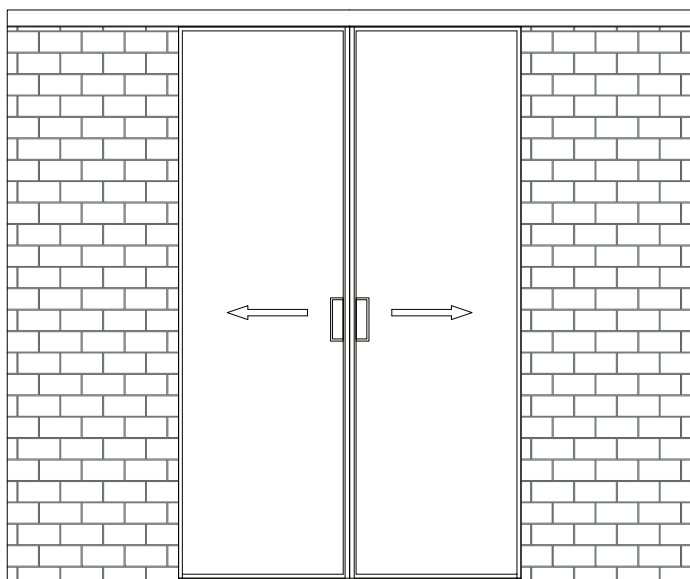

CỬA TRƯỢT SLIM 2 CÁNH

2 cánh lùa trên 2 Ray



Mã sản phẩm:

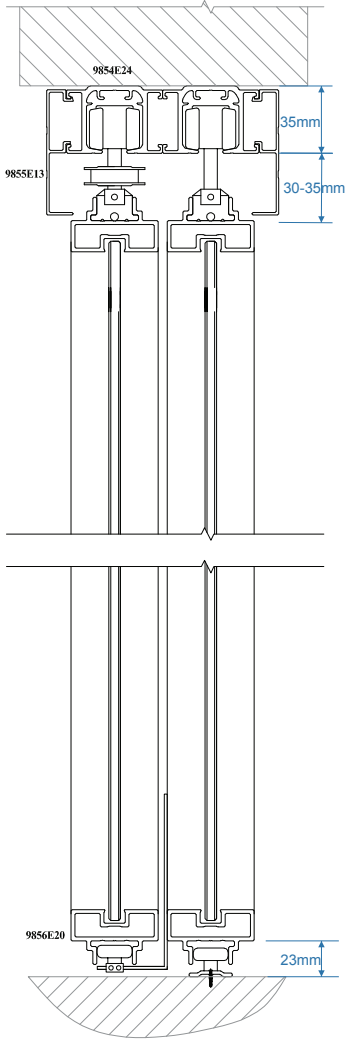
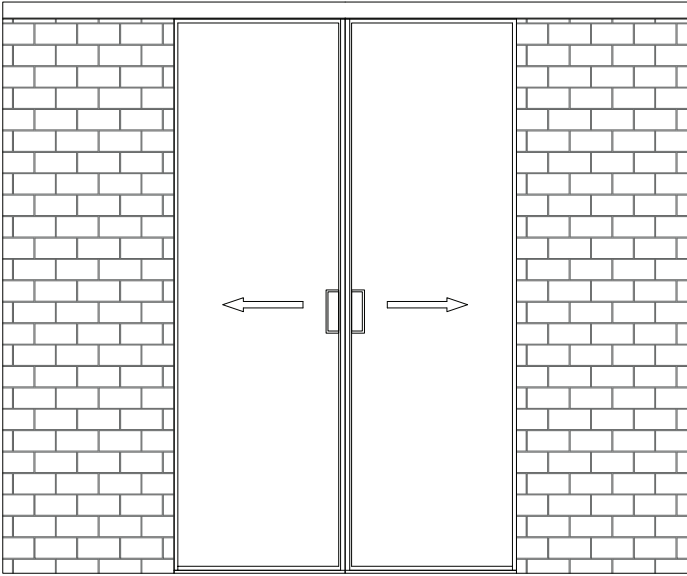

2 cánh lùa 1 cánh cố định



Mã sản phẩm:

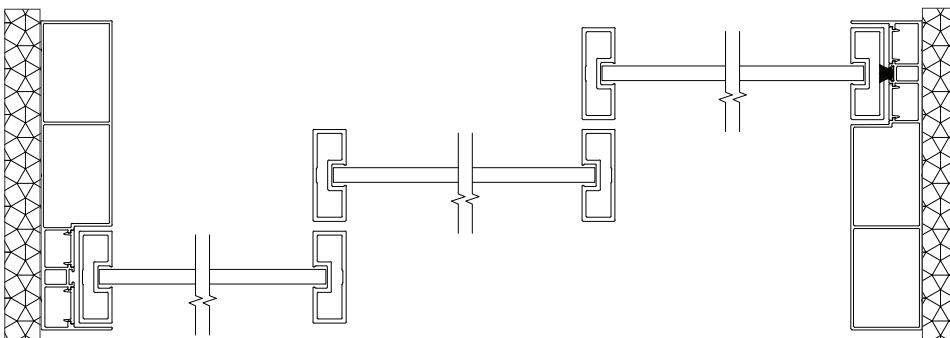
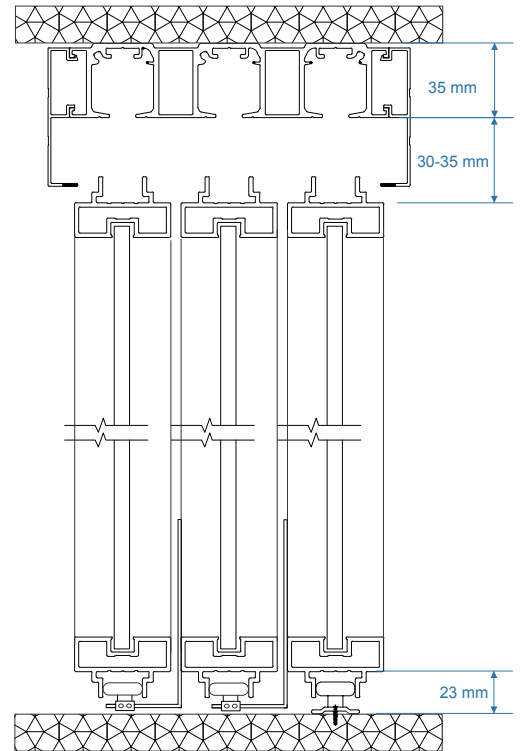
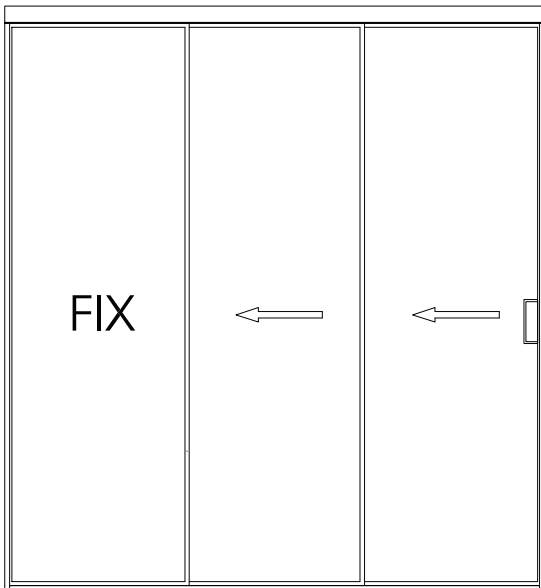

3 cánh trượt



Mã sản phẩm:

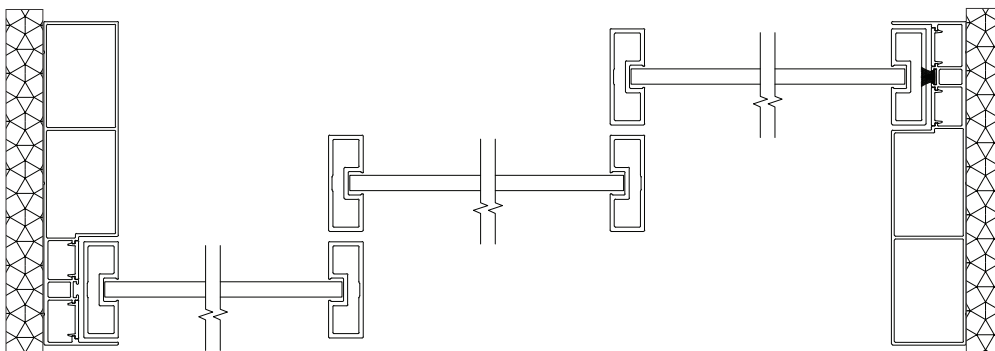
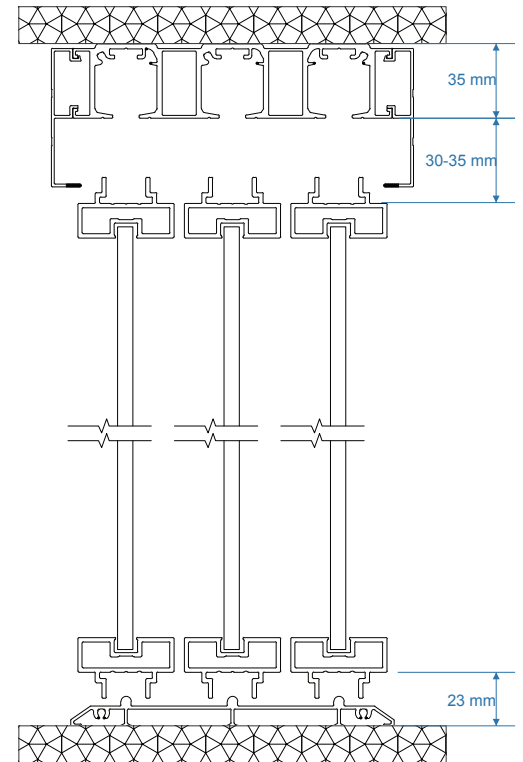
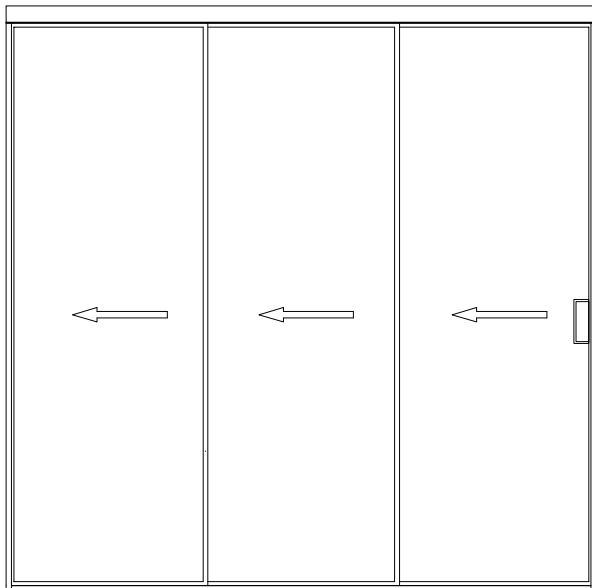

4 cánh trượt 2 bên



Mã sản phẩm:

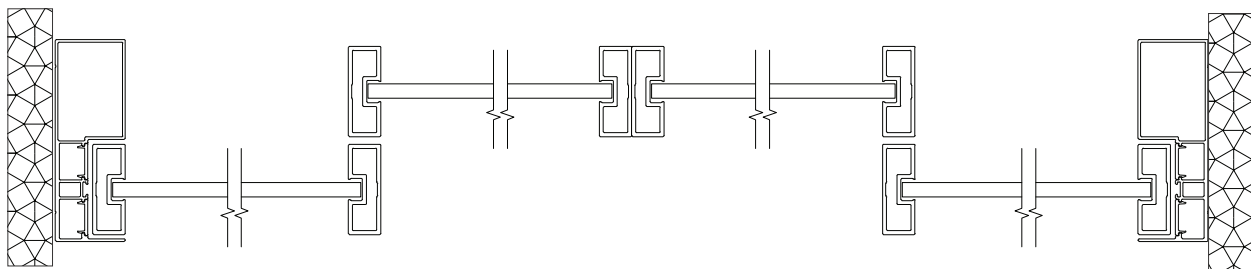
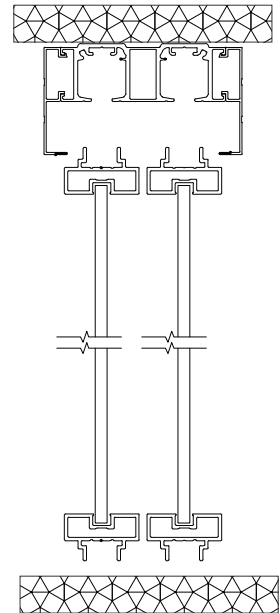
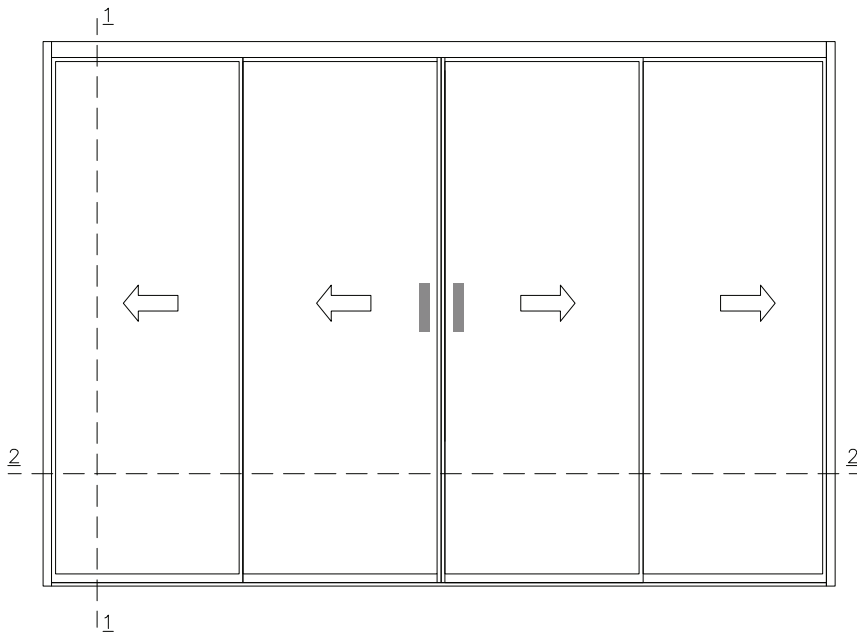

4 cánh lùa



Mã sản phẩm:

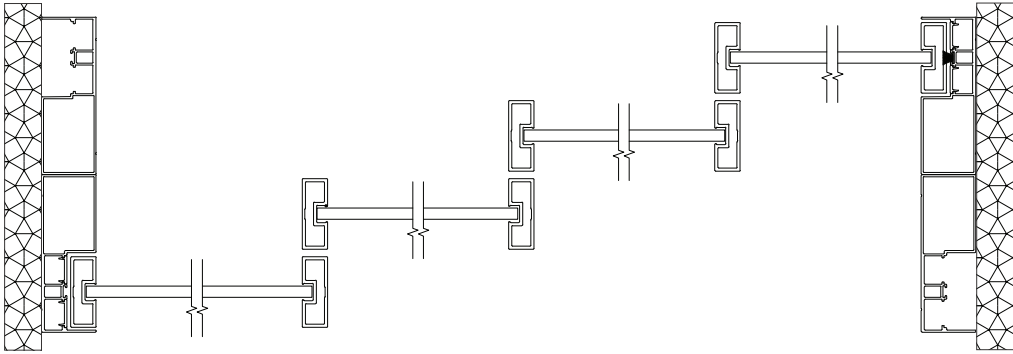
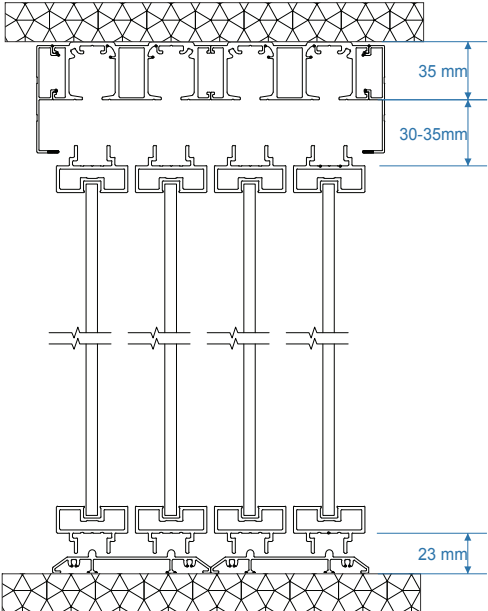
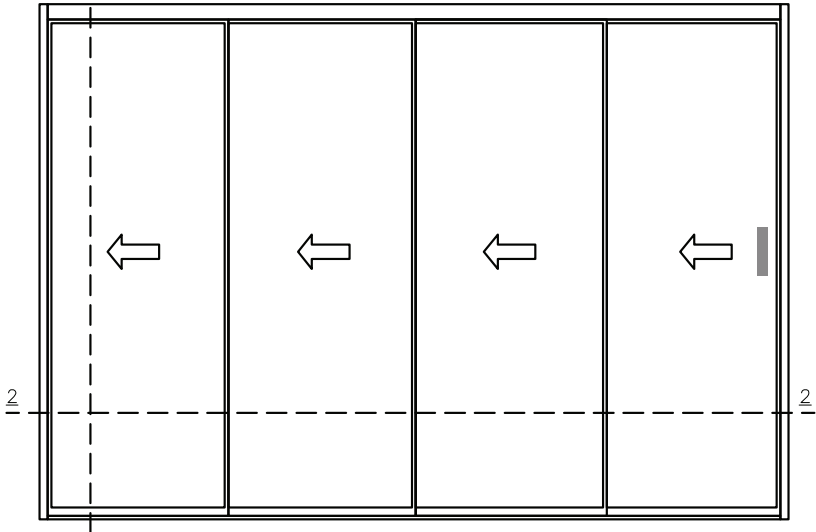



Mã sản phẩm:

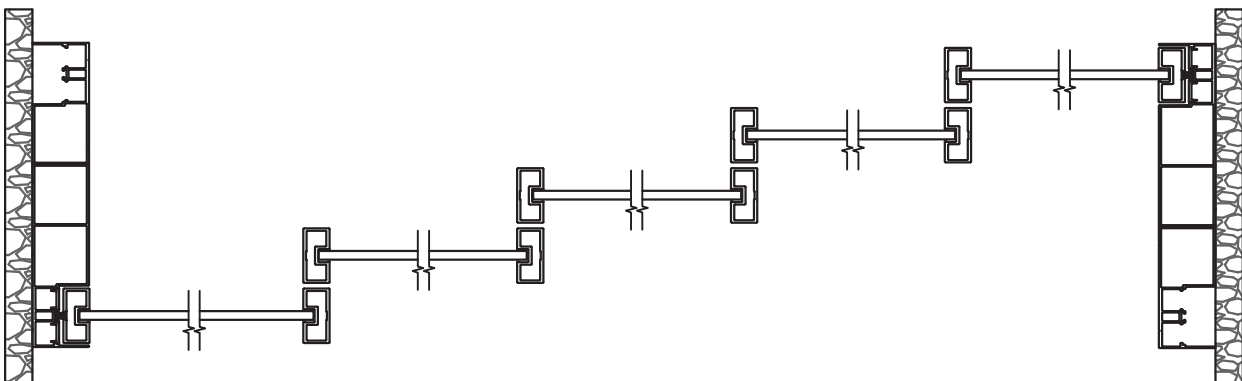
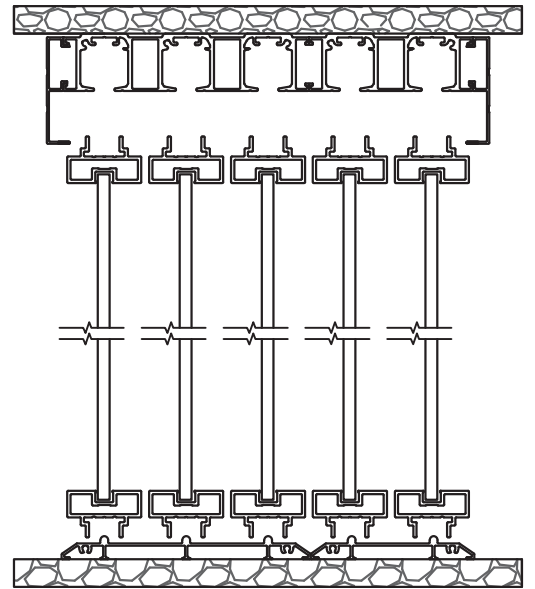
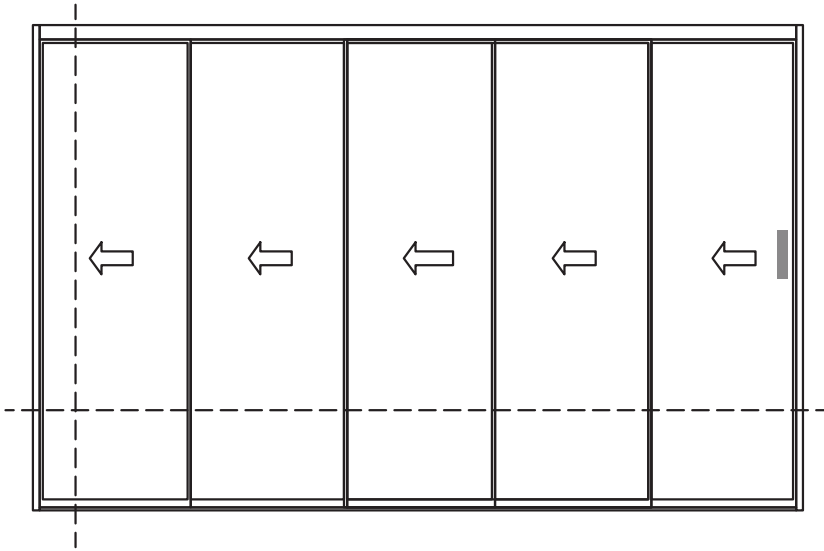





CỬA TRƯỢT SLIM 6 CÁNH

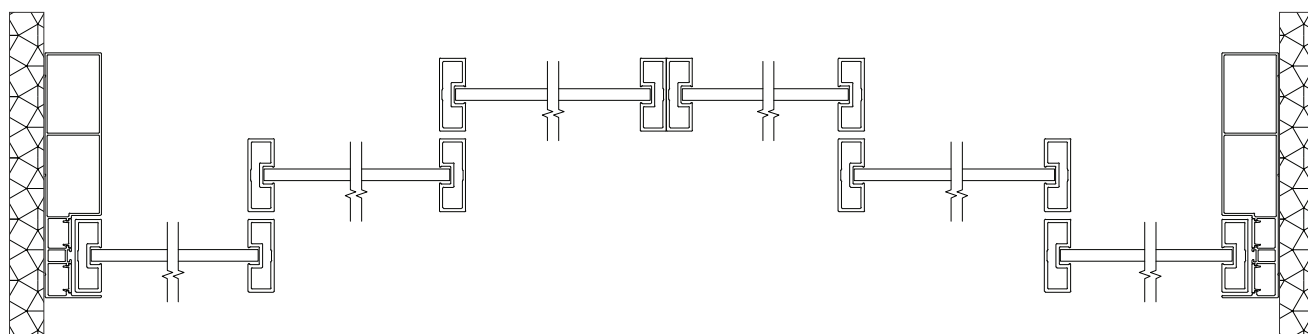
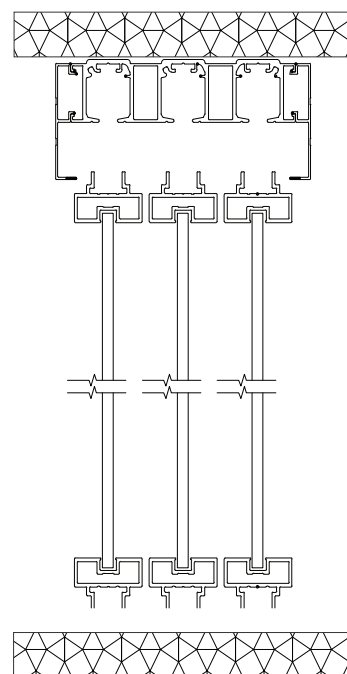
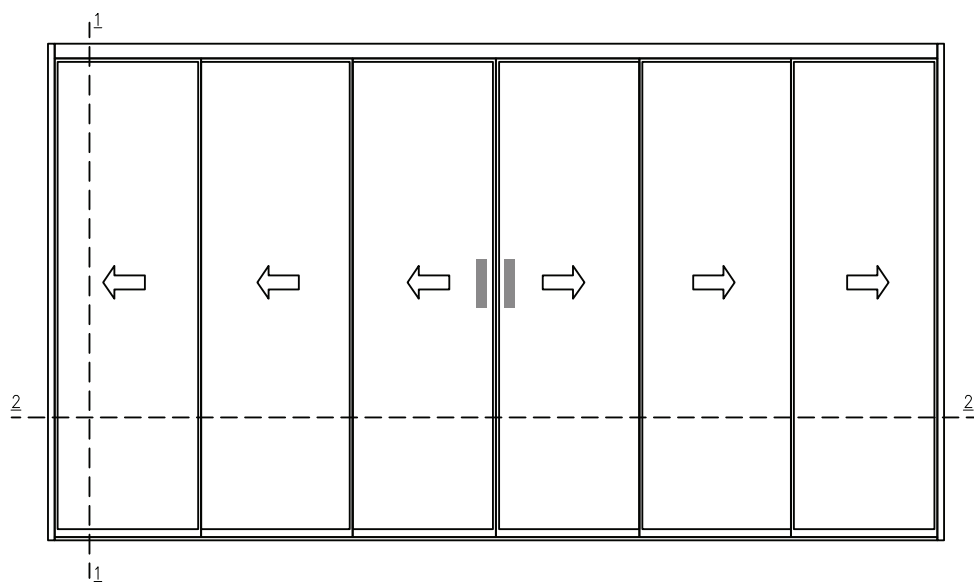

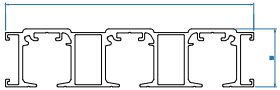
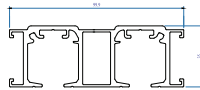
Mã sản phẩm:

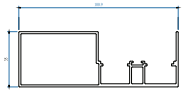
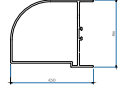

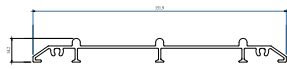
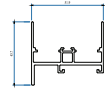
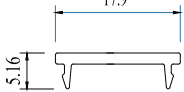
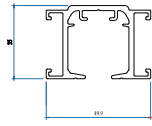
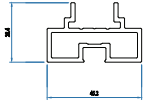
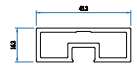
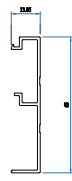
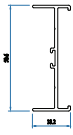
<p>RAY TRÊN 3</p> 		<p>RAY TRÊN 2</p> 		<p>ĐỨNG 3</p> 		<p>ĐỨNG 2</p> 	
Mh	Alu-1	Mh	Alu-2	Mh	Alu-3	Mh	
T (mm)	2.4	T (mm)	2.4	T (mm)	1.3	T (mm)	1.3
W (kg/m)	2.977	W (kg/m)	2.004	W (kg/m)	1.602	W (kg/m)	1.128
<p>CHUYỂN GÓC 90</p> 		<p>RAY DƯỚI 2</p> 		<p>RAY DƯỚI 3</p> 		<p>ĐỨNG 1</p> 	
Mh	Alu-13	Mh	Alu-4	Mh	Alu-5	Mh	Alu-6
T (mm)	1.2	T (mm)	1.4	T (mm)	1.4	T (mm)	1.3
W (kg/m)	0.732	W (kg/m)	0.725	W (kg/m)	1.019	W (kg/m)	0.778
<p>ỐP CÂY ĐỨNG</p> 		<p>RAY TRÊN 1</p> 		<p>CÁNH NGAN TRÊN/DƯỚI</p> 		<p>CÁNH ĐỨNG PHẢI/TRÁI</p> 	
Mh	Alu-12	Mh	Alu-7	Mh	Alu-8	Mh	Alu-9
T (mm)	1.6	T (mm)	2.4	T (mm)	2.0	T (mm)	2.0
W (kg/m)	0.094	W (kg/m)	0.986	W (kg/m)	0.855	W (kg/m)	0.693
<p>ỐP RAY TRÊN</p> 		<p>CÂY ĐÓN CÁNH-CÁNH</p> 					
Mh	Alu-10	Mh	Alu-11				
T (mm)	1.3	T (mm)	1.5				
W (kg/m)	0.383	W (kg/m)	0.383				

PHỤ KIỆN CỬA TRƯỢT SLIM

Một trong những yếu tố đem lại sự vận hành mượt mà của hệ thống cửa trượt SLIM đó là bộ phụ kiện cực kỳ thông minh. Dễ dàng thao tác tháo lắp và có độ bền cao. Được mài dũa nghiên cứu trong phòng thí nghiệm tận 3 năm để cho ra một bộ phụ kiện hoàn chỉnh. Các chi tiết ăn khớp và đồng bộ hoàn hảo



Thank you!

